

# GP Batteries

## Data Sheet

Model No.: CR1/3N

Description : Lithium Battery  
 Chemical system : Lithium Manganese Dioxide  
 Nominal voltage : 3 Volts  
 Nominal capacity : 160mAh  
 Dimensions :  $\varnothing 11.6 \times 10.8\text{mm}$   
 Shelf life : 5 years at room temperature  
 Average weight : 2.3 grams  
 Applications : watch, calculator, camera  
 and memory back up.

### Discharge Characteristics of CR1/3N

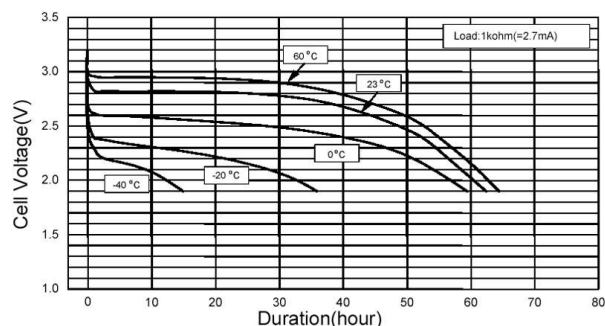

### Discharge Characteristics of CR1/3N

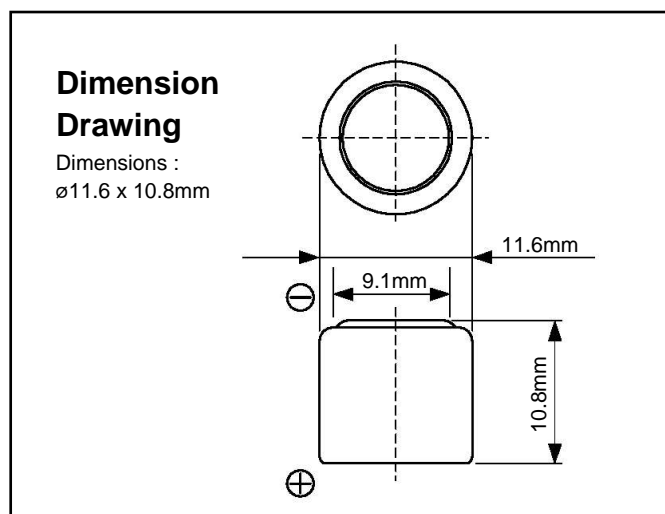
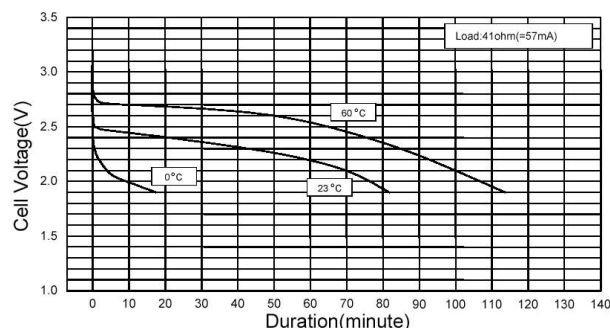

### Discharge Characteristics of CR1/3N

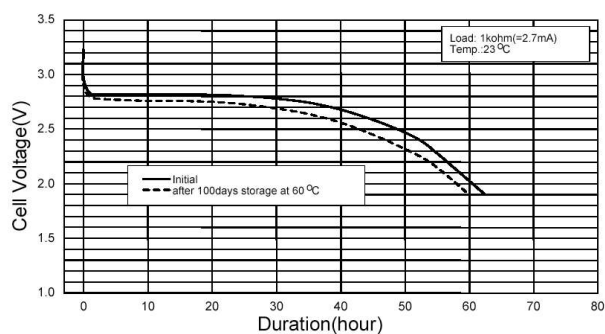

### Discharge Load vs. Capacity of CR1/3N

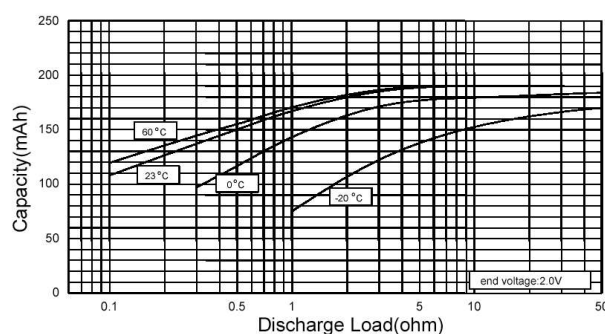

### Cross References:

SANYO	Duracell	Energizer
CR-1/3N	DL1/3N	2L76